

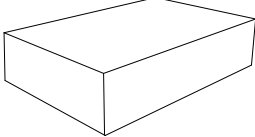















# Assembly Installation

## Inset Set WDC Cabinet

	Item	Name	QTY		Parts	QTY	
 Packing		Tool Needed Screwdriver or Power Drill	2	 Hardware Box		Hinges	2
		A	2			Cam-lock Wheel	10
		D	2			4*16 MM Screw	32
		F	2			Cam-lock Post	10
		B	2			4*30MM Screw	2
		C	1			Shelf Holder	8
		E	1				
		H	1				

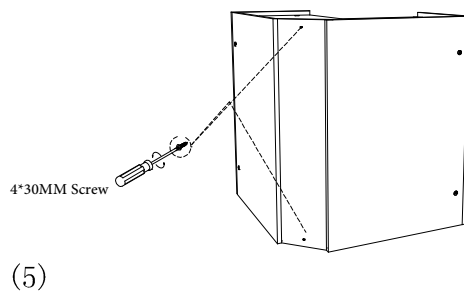
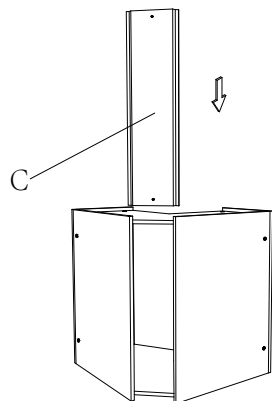
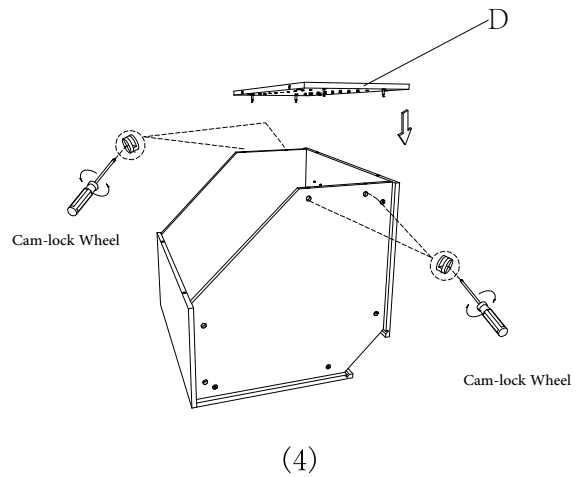
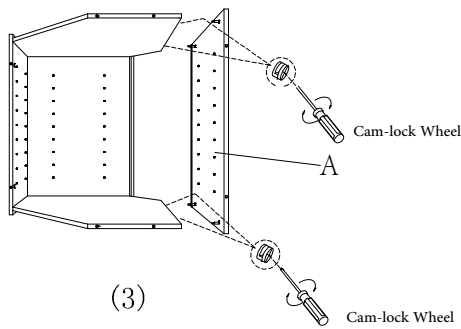
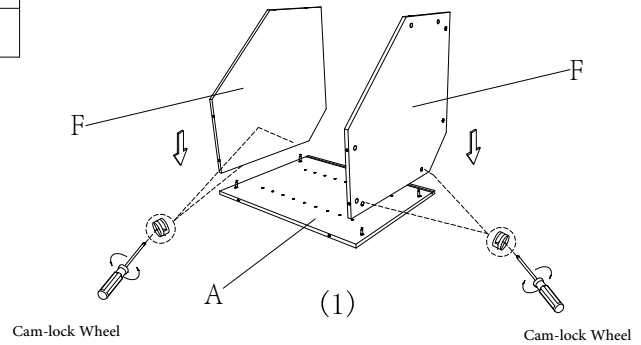
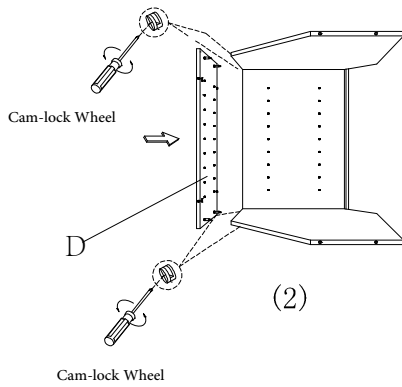

# Assembly Installation

## Inset Set WDC Cabinet

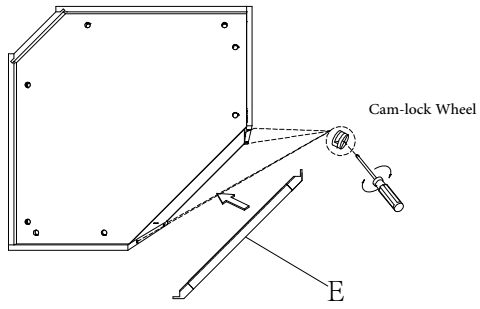

(6)

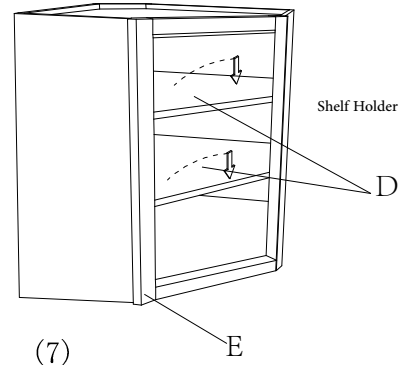

(7)

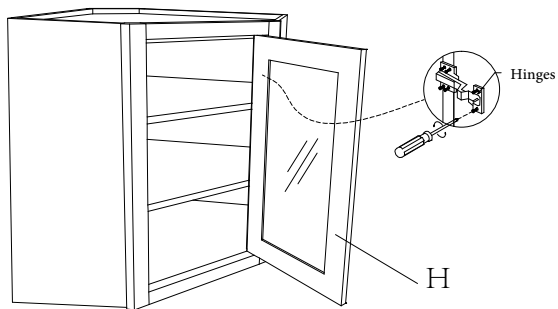

(8)

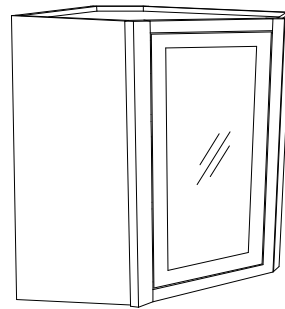

(9)