

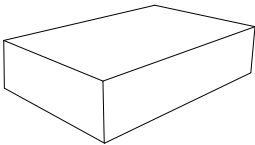









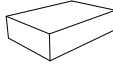



Assembly Installation







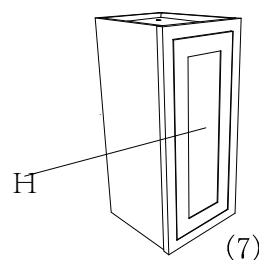
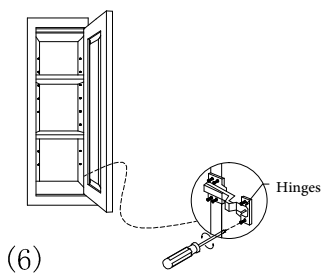
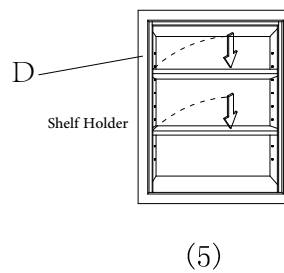
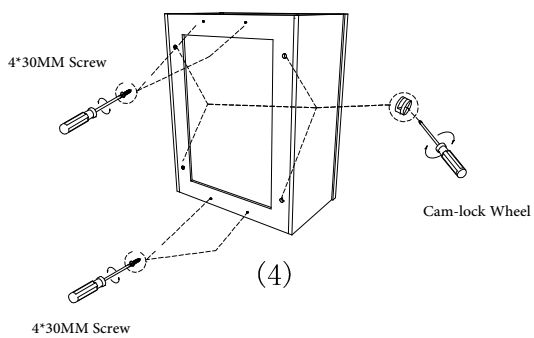
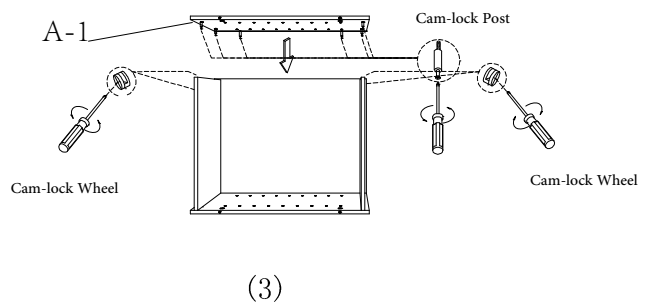
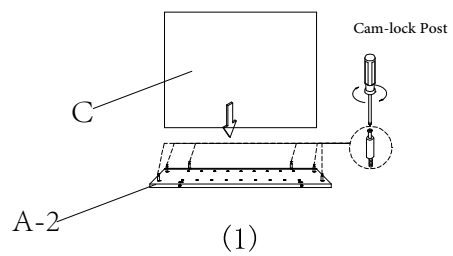
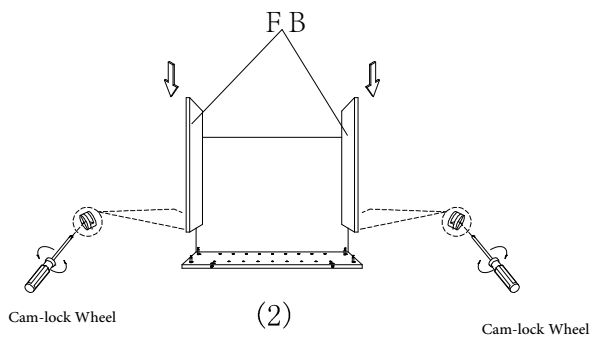



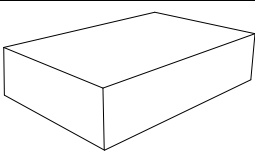

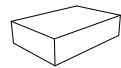

Inset Set Wall Cabinet

	Item	Name			Parts	QTY	
 <p>Packing</p>		Tool Needed Screwdriver or Power Drill	2	 <p>Hardware Box</p>		Hinges	2
		A-1	1			Cam-lock Wheel	10
		A-2	1			4*16 MM Screw	16
		F B	2			Cam-lock Post	10
		C	1			4*30MM Screw	2
		D	1			Shelf Holder	8
		H	1				



Assembly Installation

Inset Set Wall Cabinet

	Item	Name			Parts	QTY	
 Packing		Tool Needed Screwdriver or Power Drill	2	 Hardware Box		Hinges	4
		A-1	1			Cam-lock Wheel	10
		A-2	1			4*16 MM Screw	32
		F B	2			Cam-lock Post	10
		C	1			4*30MM Screw	2
		D	1			Shelf Holder	8
		H	2				

